

**kvik** 

**DBU4822,060,228-229**

**BU5160,000**

**US4851,000**

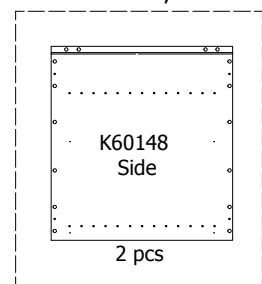
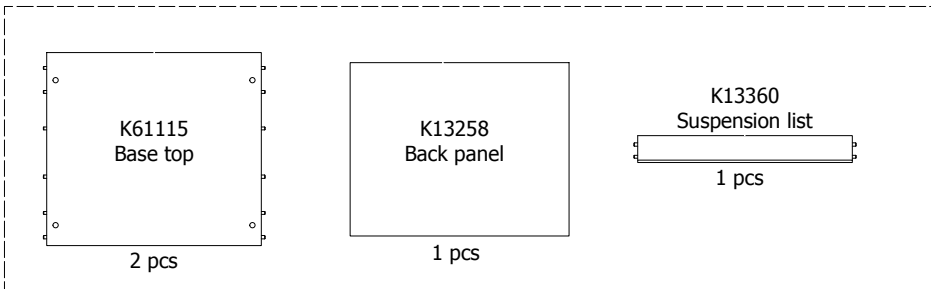

**B4023**

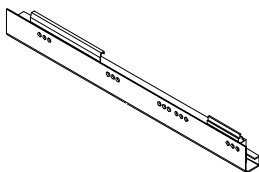
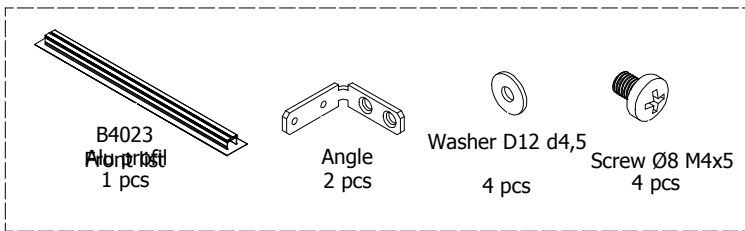

**Drawer slide Left**  
450  
2 pcs

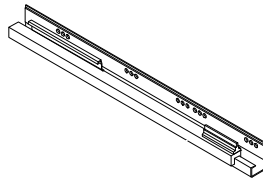

**Drawer slide right**  
450  
2 pcs

**BP00260-BP00250**

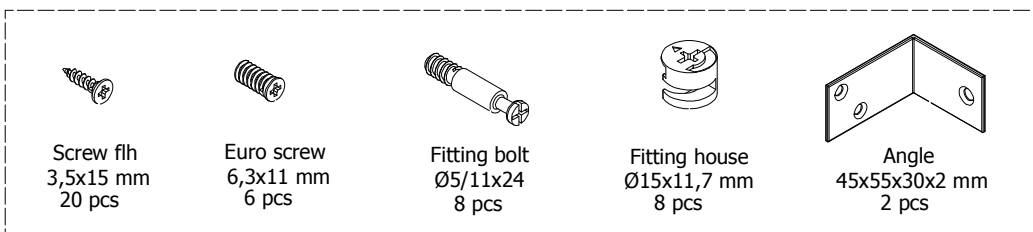

FIG. 1

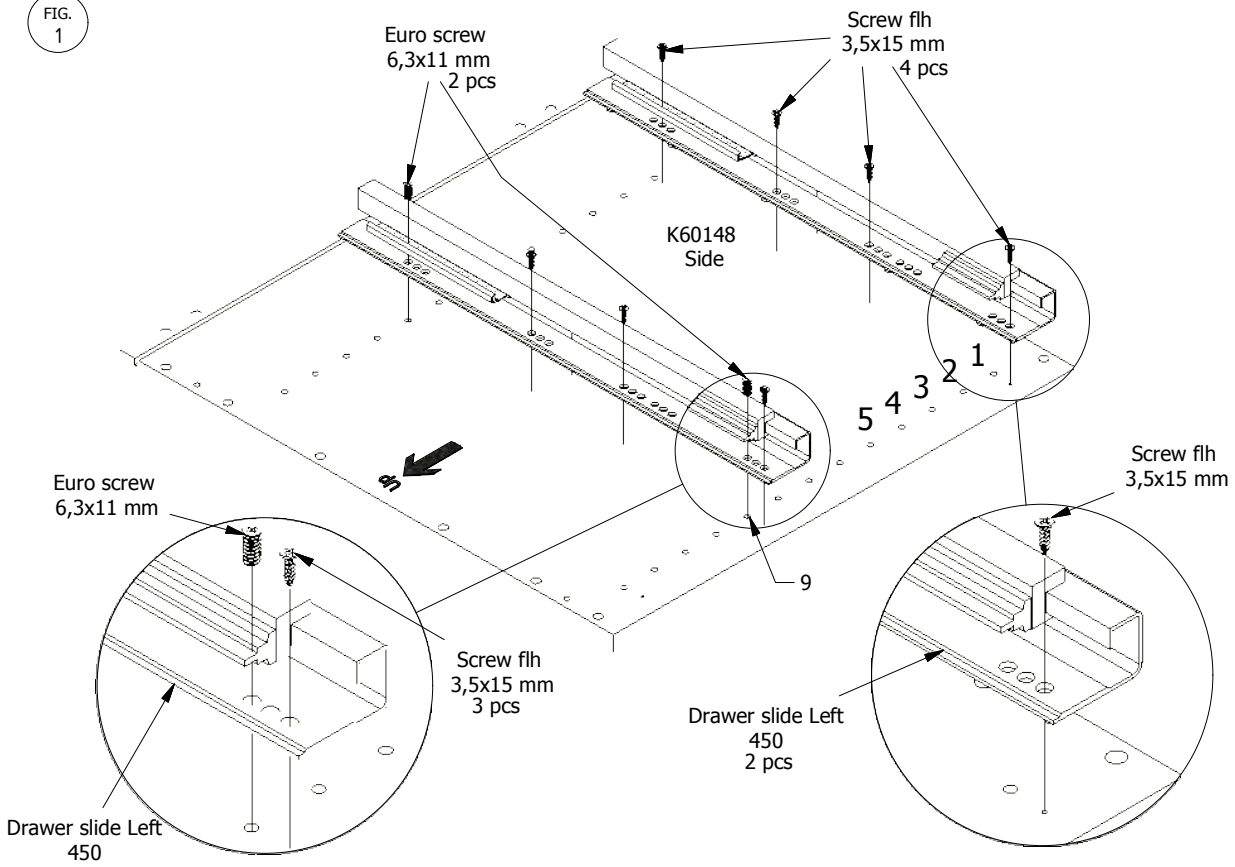

FIG. 2

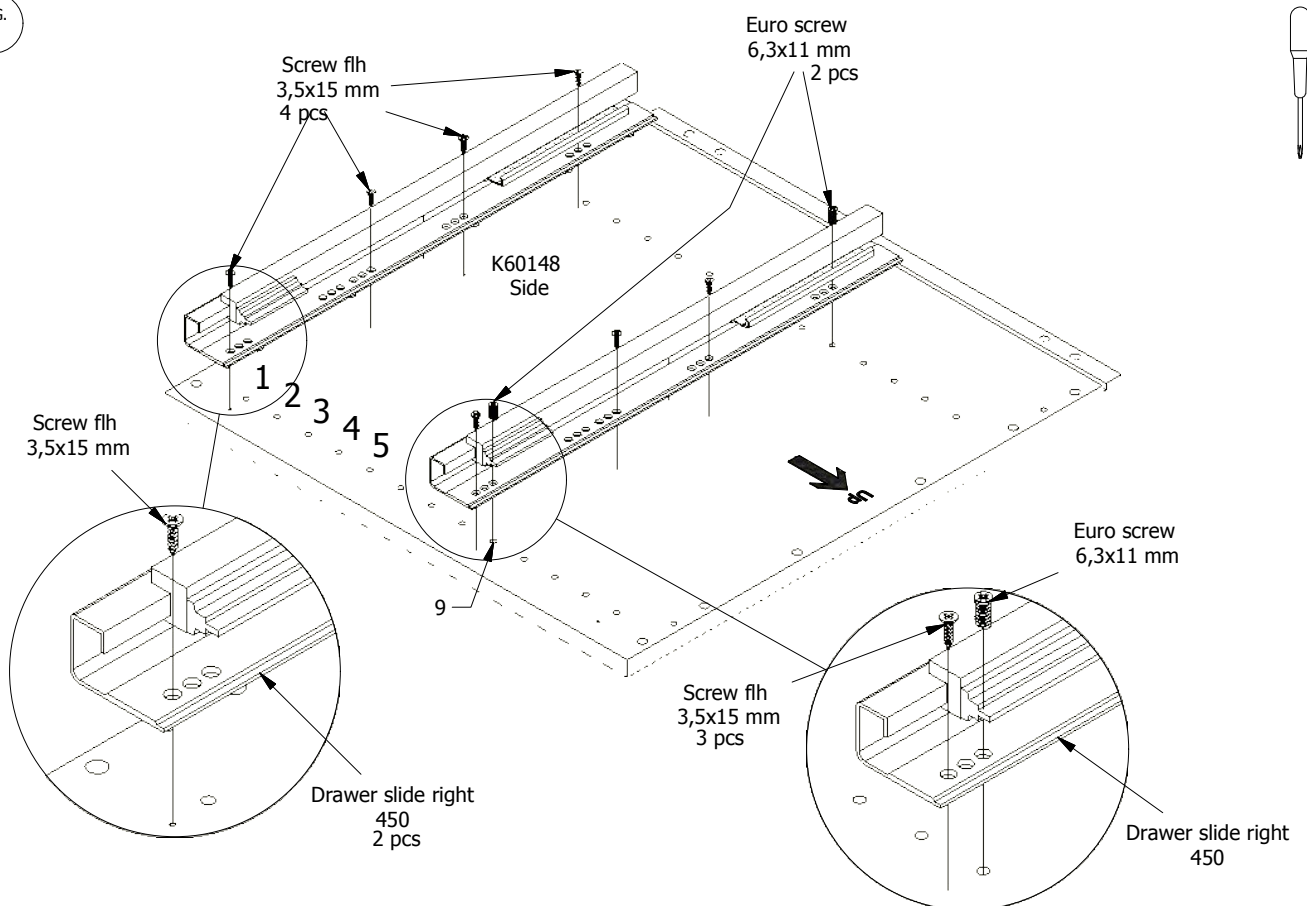

FIG. 3

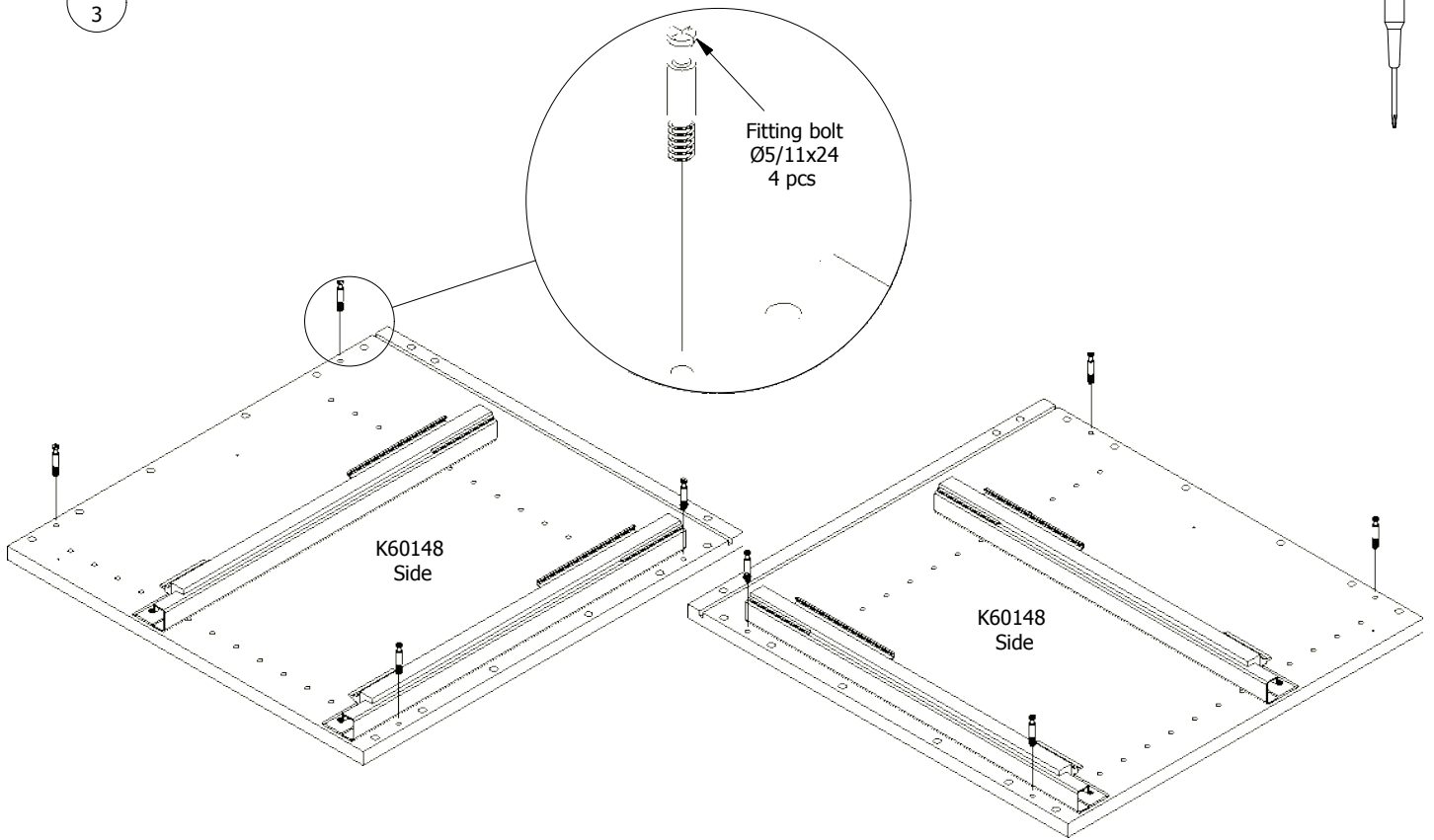

FIG. 4

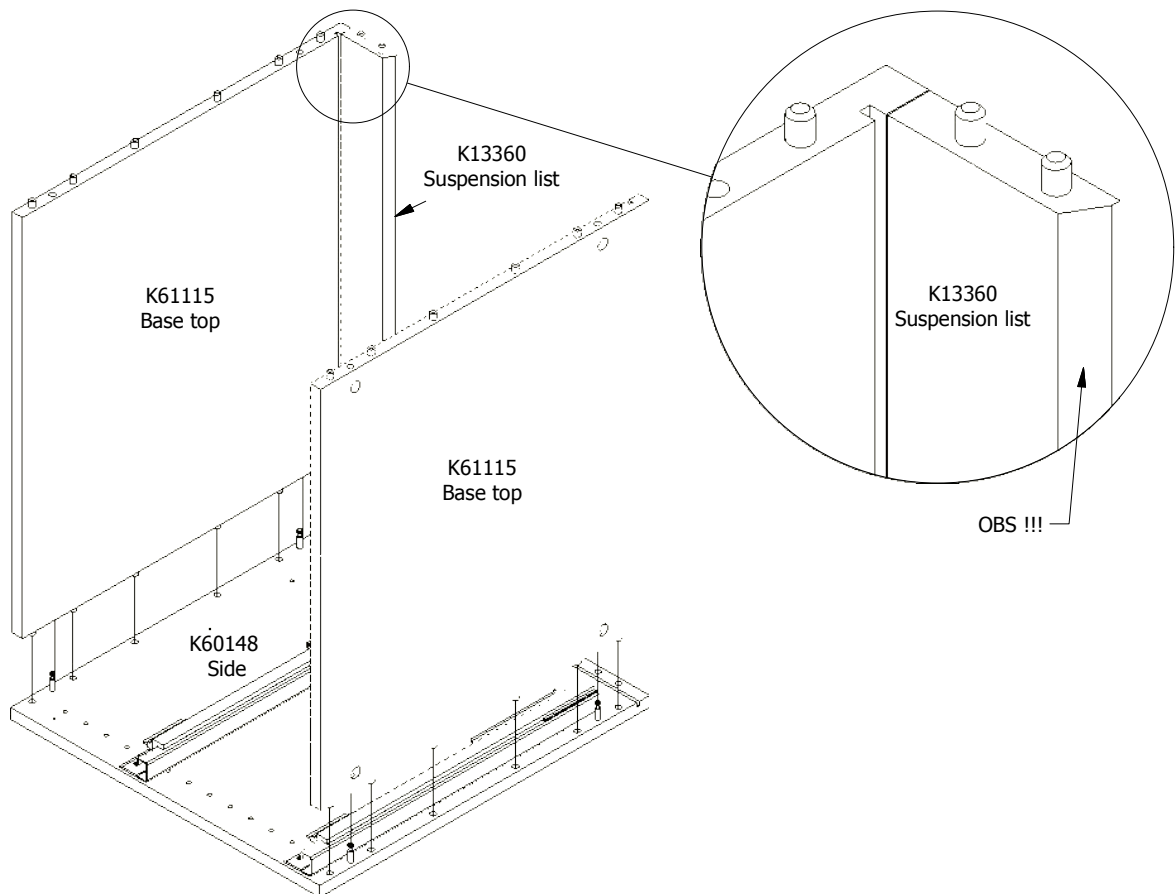

FIG.  
5

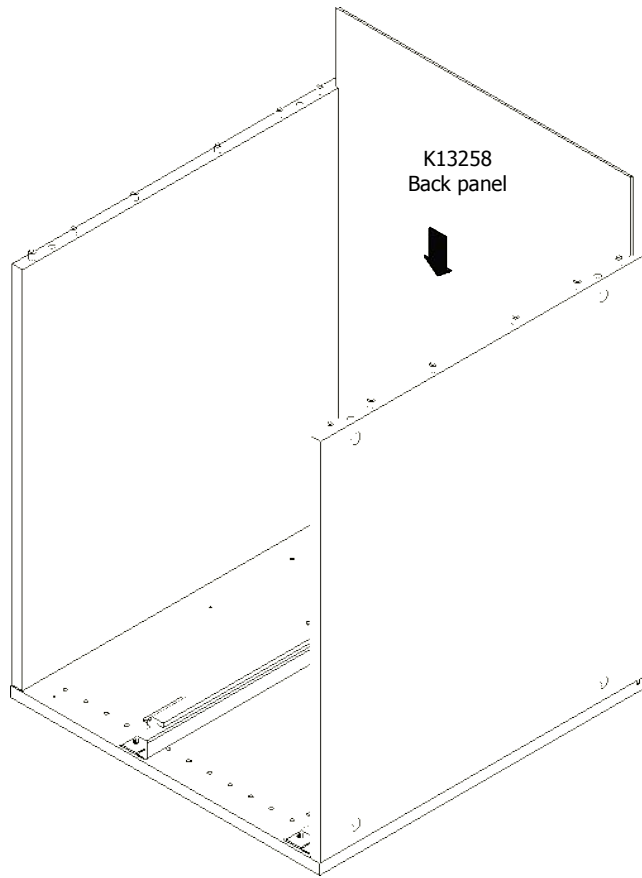

FIG.  
6

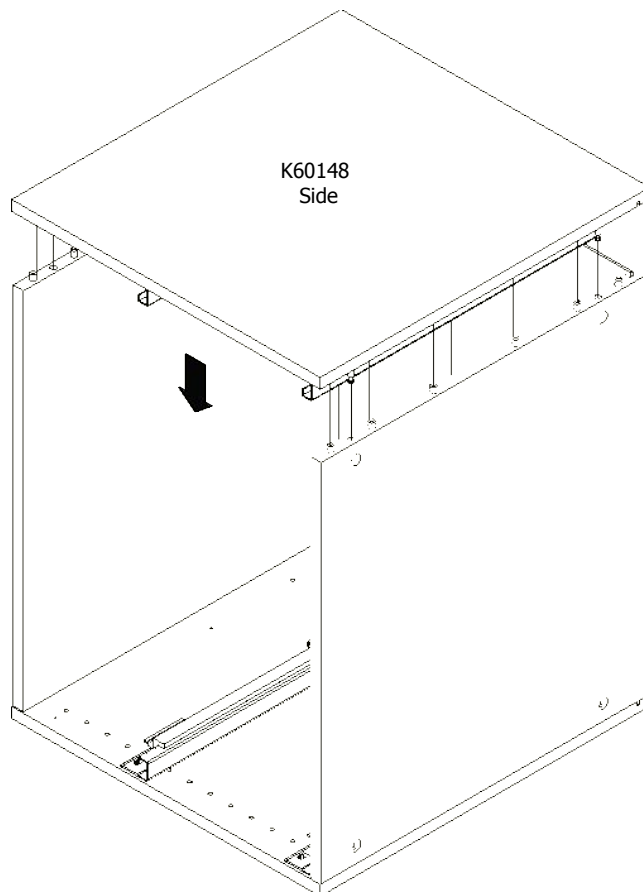

FIG. 7

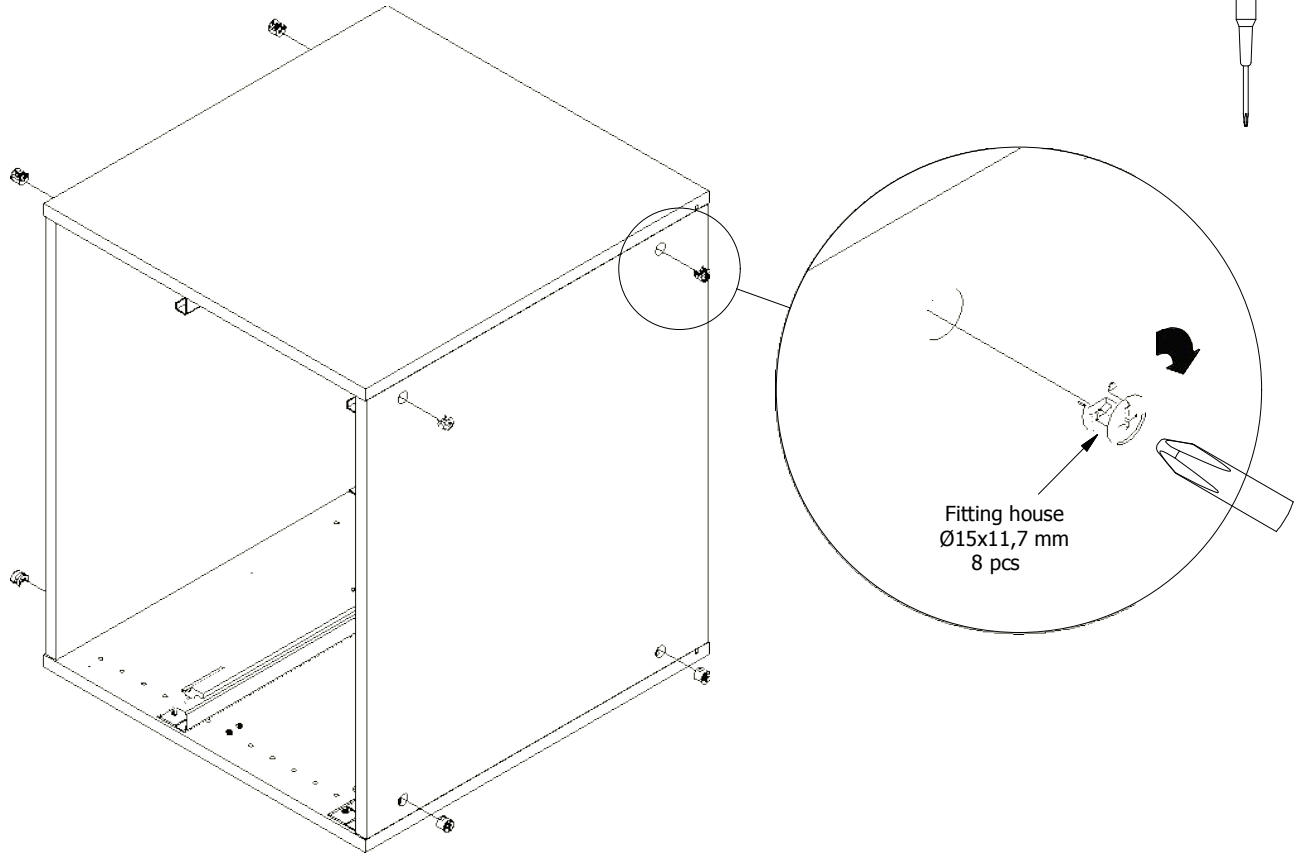

FIG. 8

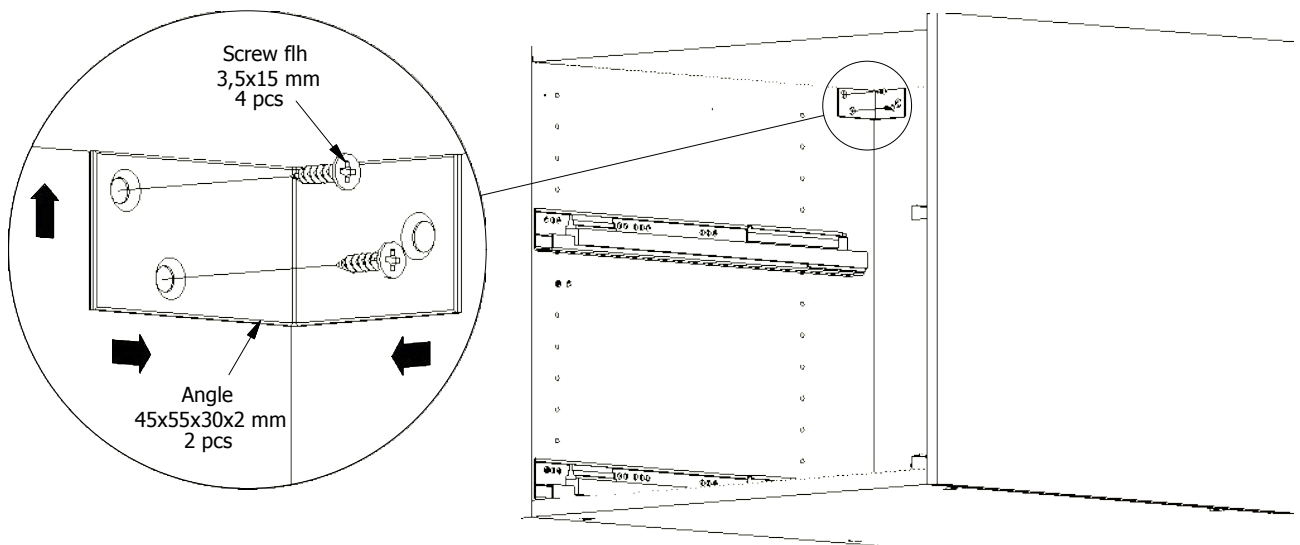

FIG. 9

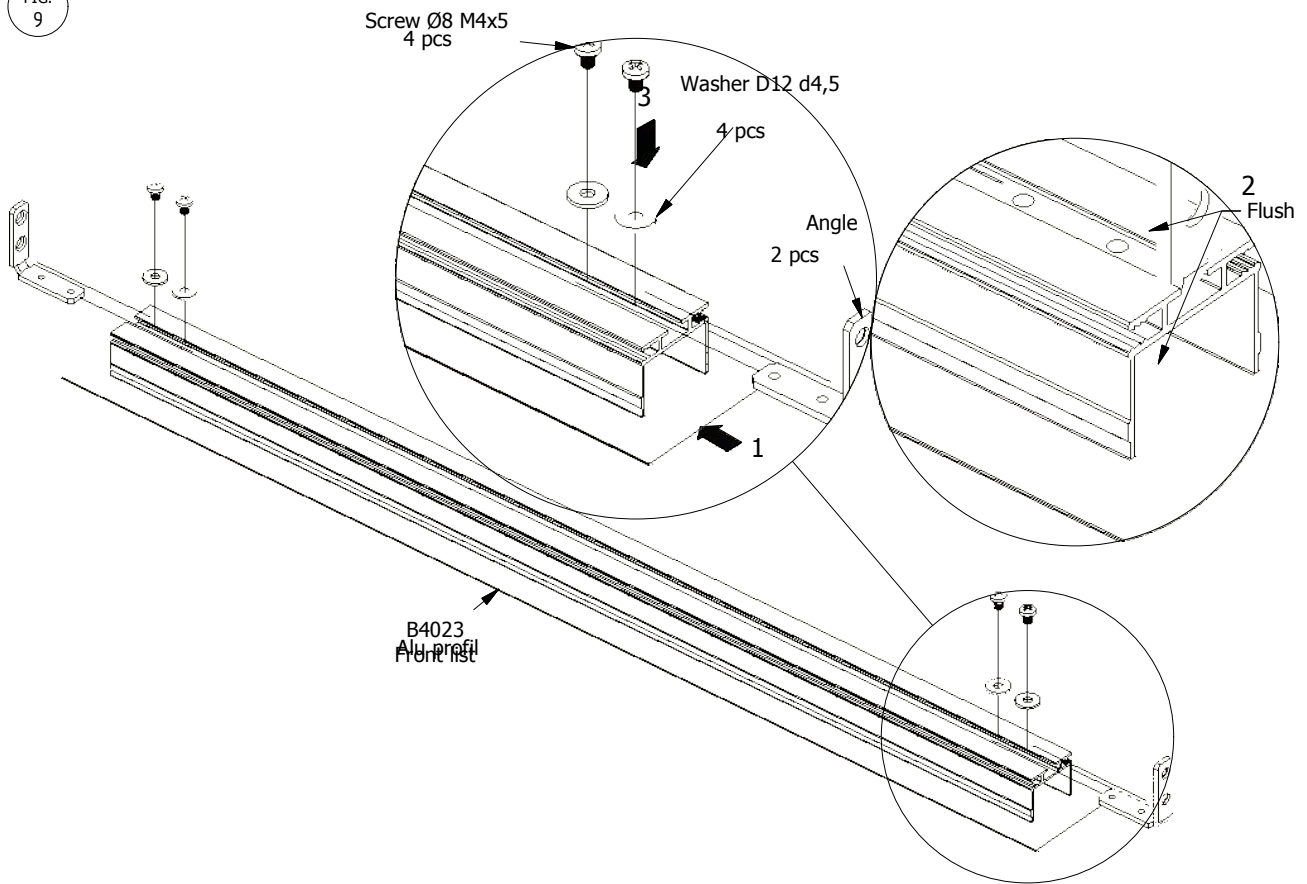

FIG. 10

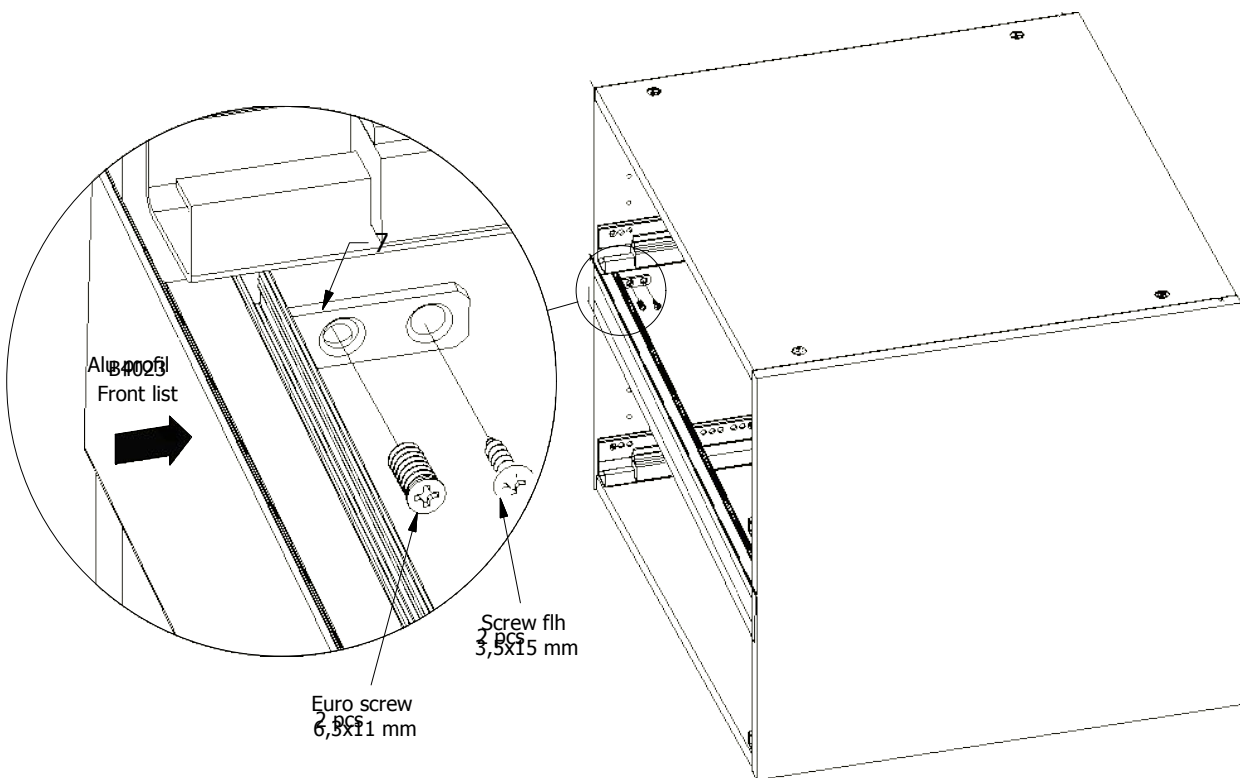

FIG.  
11

